

Veranda

by ultraframe



Glazed extensions





Veranda the exciting, contemporary home extension from Ultraframe...

Conservatories have always been an excellent way for consumers to blur the margin between home and garden, but Ultraframe is taking the idea to a new level with its Veranda conservatory. The glazing bars in the roof oversail and carry the glass with it, to form a 'cocoon' where the consumer can sit in the garden and be protected from the worst of the elements.

Moreover, on a warm day - by using large in line sliders or bi-fold doors your customer then has a much bigger space to enjoy, perfect for family barbeques!!

Winter or summer, a Veranda could be **the** dream home addition.



◀ Bi-folding doors open up the front of the building - let the outside in.

The light, bright and airy interior will add a new dimension to your home and provide a seamless link between your home and garden.



▲ Veranda can be executed in a number of different ways:

- Between two walls of the same length
- Between two walls of varying lengths
- In reverse pitch situations

- Mono pitch or duo pitch
- On top of glazed side frames
- As 'wrap arounds'

Colour applied correctly has a profound positive effect on your wellbeing. It strongly influences how we interact with each other and our surroundings... so do you stick to conventional conservatory colours / finishes or do you choose something different?

Carefully chosen colours creates a space that works best for you and your home. Consider this...

Black

Powerful, sophisticated, substantial, uncompromising, reveals hidden potential

White

The colour of purity, well balanced, optimistic, and generous,

Cream

Stimulates the intellectual side of the brain and brings out feelings of happiness.

Greens

Not surprisingly green has a strong affinity with nature, offers harmony and balance and is mentally and physically relaxing.

Greys

Independent, individualistic and subtle, grey shields us from outside influence.

Browns

The colour of Mother Earth, brown brings stability and alleviates insecurity. Nurturing and supportive



White

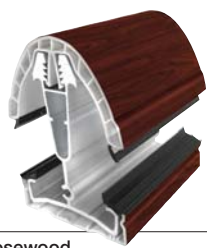

Rosewood

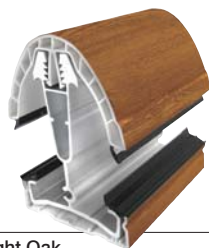

Light Oak



Irish Oak

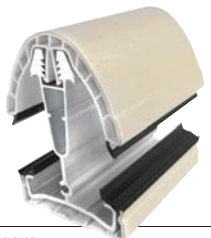

Cream

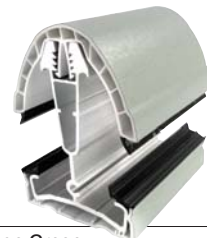

Sage Green

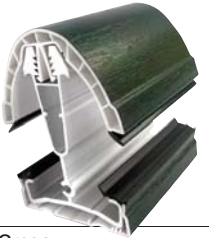

Fir Green

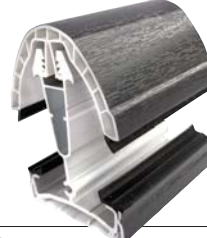

Grey



Ebony Black

Colour can be used on the roof and frames and applied in a number of different ways.

Powder coated aluminium suite

Spray paint the PVC elements

Foil lamination and spray painting

Depending upon your particular project your retailer will advise you on which method will work best for your Veranda



PVC foil laminated colours (above) and choose from the RAL colour chart if specifying aluminium

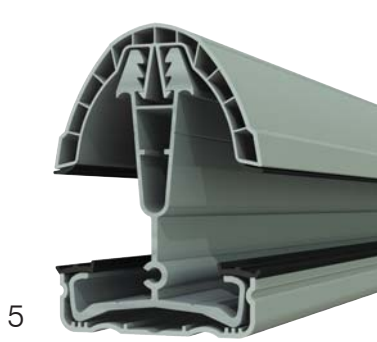
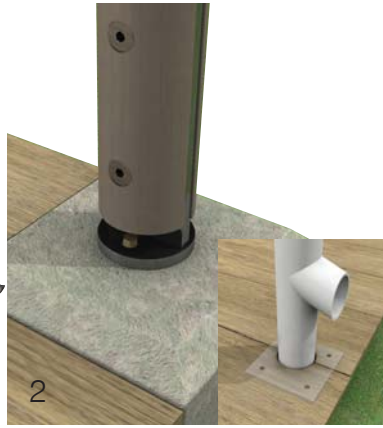

▲ 1. Rain Gutter detail
 2. Bottom Bracket - Oakpost
 (INSET: Aluminium combi support post/downpipe)
 3. Veranda Beam Assembly
 4. Half Ridge Assembly
 5. Classic Glazing Bar
 6. Super Duty Eaves Beam
 - Typical detail over doors

System elements

At the core of the Veranda is either the Classic or Classic Plus roof (Classic Plus glazing bar illustrated). At the intersection between internal and external space is the Super Duty Eaves Beam*, clad internally with the PFTB planked fascia and externally with a powder coated aluminium fascia.

The main Veranda beam is constructed from powder coated aluminium and acts as an integral gutter and support beam. Posts are part of the structural support package.

There are two types of post - aluminium or oak. The oak post comes complete with gasketed stopends and splice plates to connect to the base.

An alternative to the oak post is the aluminium support post - this can mutually fulfill 2 functions when fabricated, as rain water pipe and post.

* On certain Veranda designs and on very wide openings, a 'goal post' support arrangement will be necessary and of course Ultraframe can design and manufacture this.

Veranda Beam Span - with 0.6kn/m² snow loading 4/16/4 glass

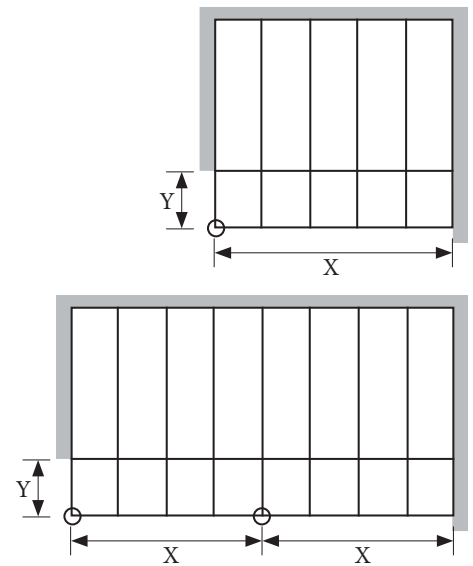
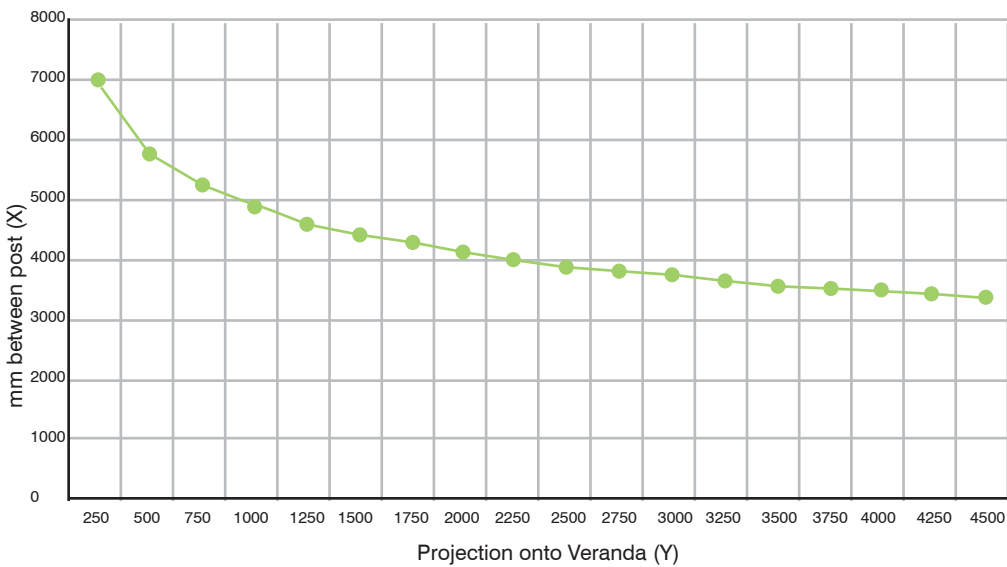

For loading condition other than 0.6kn/m² (with 4-16-4 glass units) please let our specification team know. Ultraframe's U-Design software simply needs your home postcode to calculate the loads and the resulting roof specification.

Veranda Set Outs

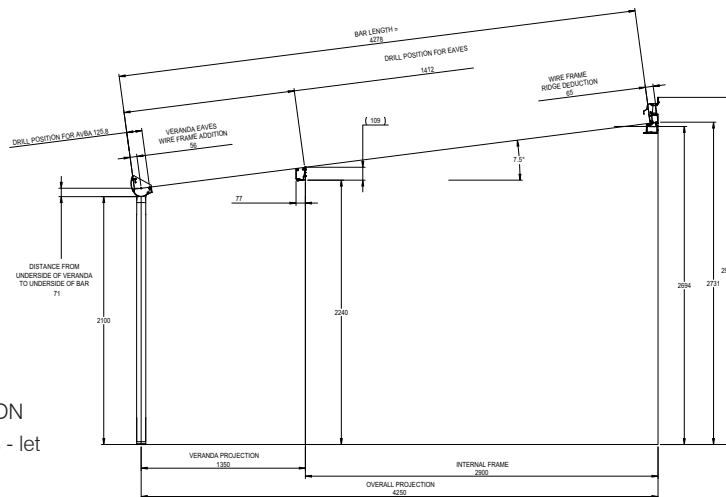

TYPICAL LEAN-TO IN CROSS SECTION
Naturally, we can vary the dimensions - let your retailer know your requirements



Loggia Prestige

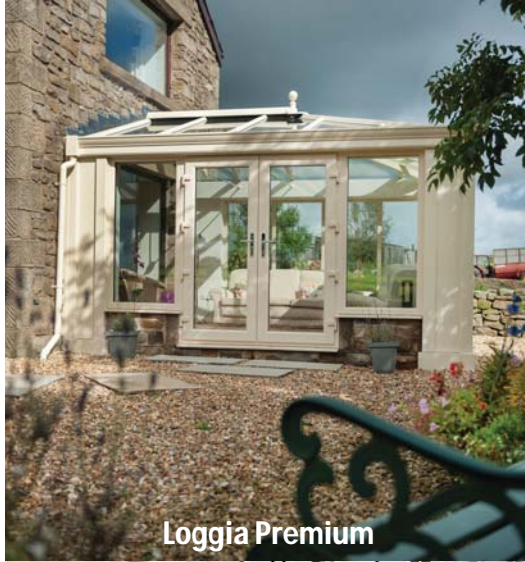

Loggia Premium

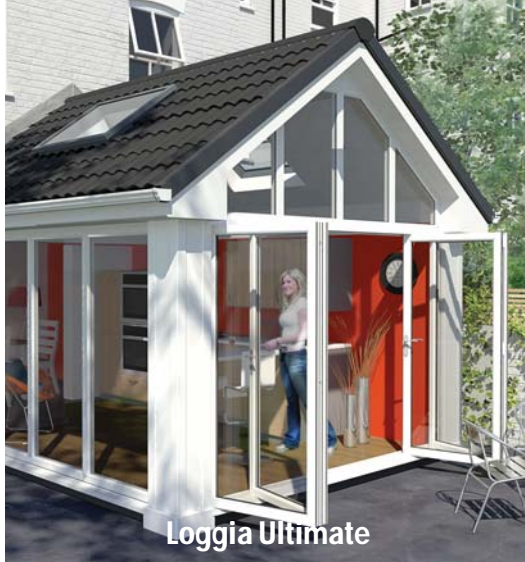

Loggia Ultimate

QUANTAL

www.quantal.co.uk

ultraframe
Transforming light and space

www.ultraframe.co.uk